

# HOZAN

TOOLS FOR BICYCLE

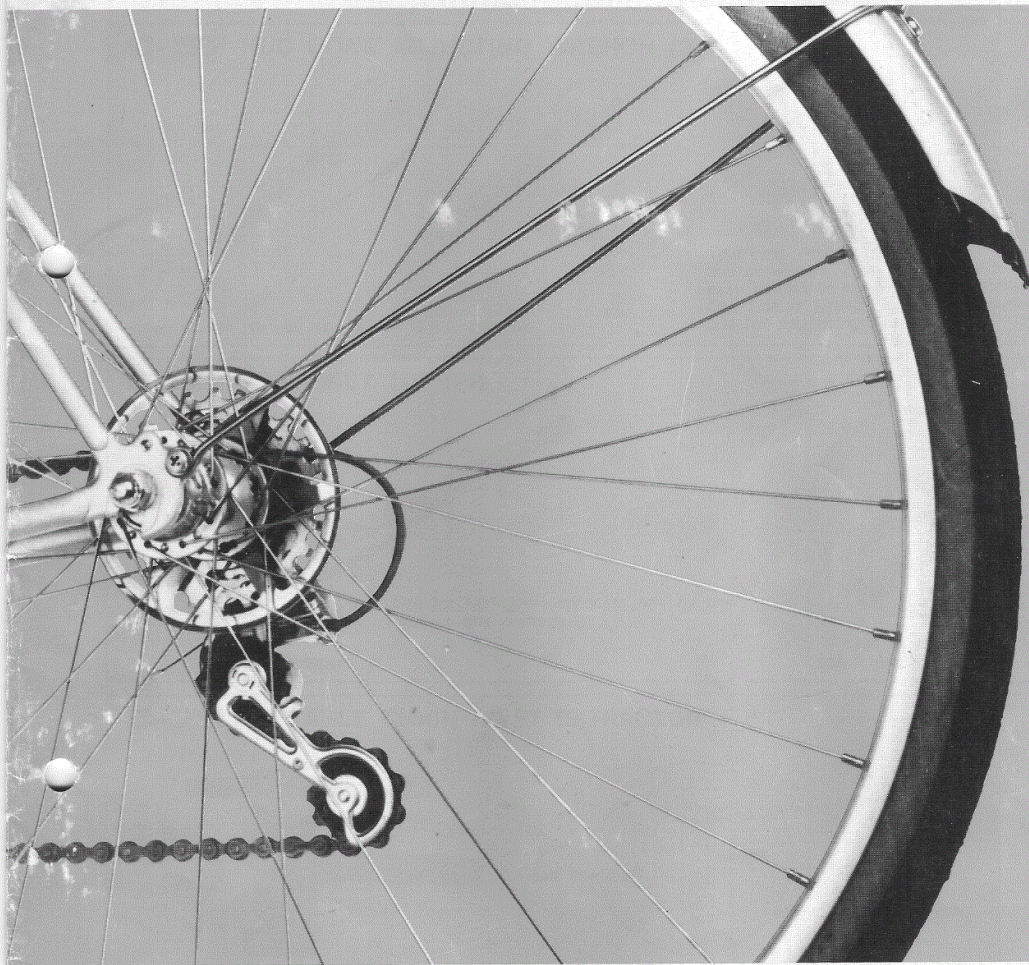

 *FROM ASSEMBLY  
TO SERVICING*

HOZAN TOOL IND. CO.,LTD.

**C-51 REPAIRING ROLLER FOR INNER TUBE**

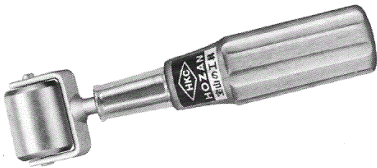

Back and forth over the patched area several times, then the patch will stick completely.  
O.A.L. 165 mm

**C-55 SCISSORS**



Use for cutting job of patch rubber and tubes.  
O.A.L. 180 mm

**C-68 TIRE LEVERS (3 PCS. SET)**



Unique slotted design for hooking on spoke. For wired on tires.

**C-57 HUB CONE ADJUSTING WRENCH (3 PCS. SET)**

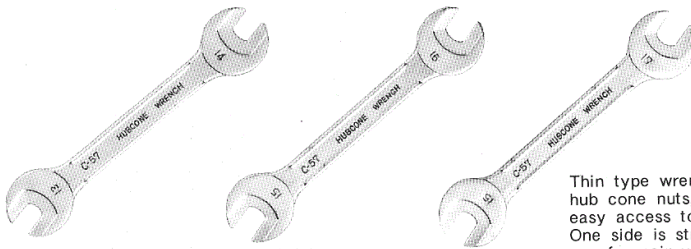

Size : 13×14, 15×16, 15×17 mm O.A.L. 230 mm

Thin type wrench for adjusting hub cone nuts, open end design permits easy access to hard-to-get adjustments. One side is straight and others curved one for pair using like fig.

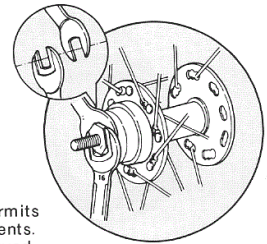

**C-62 SPROCKET TURNER**



Use for taking off sprocket one by one without any damage.

O.A.L. 360 mm

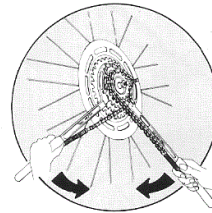

In case of take off, use 2 pcs. of C-62

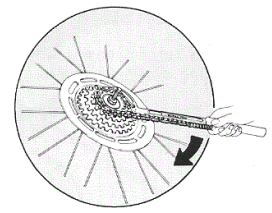

In case of set up

**C-70 PORTABLE CHAIN RIVET EXTRACTOR**

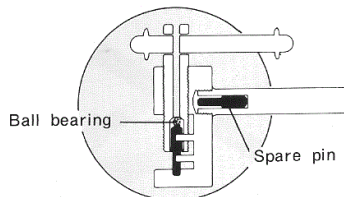
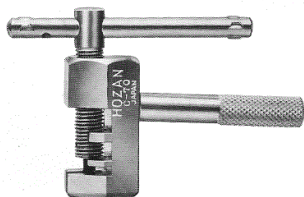

As built in ball bearing, you can extract it sure, easily without slip off. To suit all cycle chain, light weight and small type, especially for touring and home use.

**C-71 SPARE T-BAR**

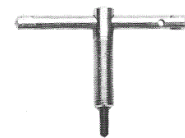

**C-72 SPARE PIN**



**C-73 · C-74 MINI. Y-TYPE BOX WRENCH**

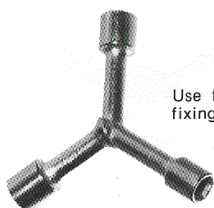

Use for lamps setting screw, brake band fixing screw.

C-73 8×9×10 mm C-74 11×13×14 mm

**D-378 CRANK CAP DRIVER**

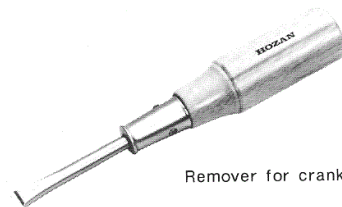

Remover for crank dust cap.

O.A.L. 180 mm

# CYCLE TOOLS

**C-103 4-HOLE BOX WRENCH**

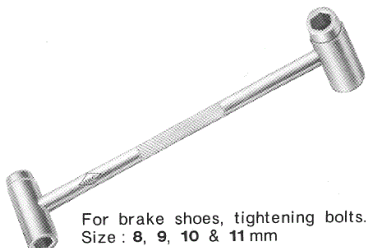

For brake shoes, tightening bolts.  
Size : 8, 9, 10 & 11 mm  
O.A.L. 205 mm

**C-110 FORKED SCREW DRIVER FOR PEDAL CONE**

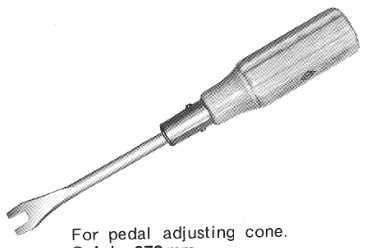

For pedal adjusting cone.  
O.A.L. 270 mm

**C-112·113·114 DOUBLE ENDED BOX WRENCH**

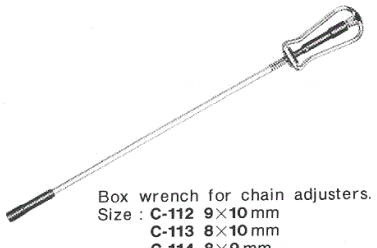

Box wrench for chain adjusters.  
Size : C-112 9×10 mm  
C-113 8×10 mm  
C-114 8×9 mm

**C-119 SPOKE WRENCH (1-5/8" dia.)**

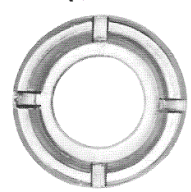

4 grooves for 14, 15 G.  
Chrome plated.

**C-120 SPOKE WRENCH (1-5/8" dia.)**

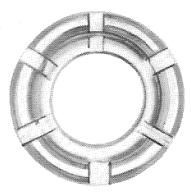

6 grooves for 10-15 G.  
8 grooves for 9-15 G.  
Chrome plated.

**C-121 SPOKE WRENCH (1-3/4" dia.)**

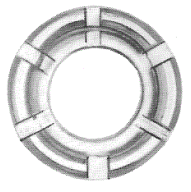

6 grooves for 10-15 G.  
8 grooves for 9-15 G.  
Chrome plated.

**C-130 CHAIN CASE REFORMER**

You can reform easily without detaching stay and chain.

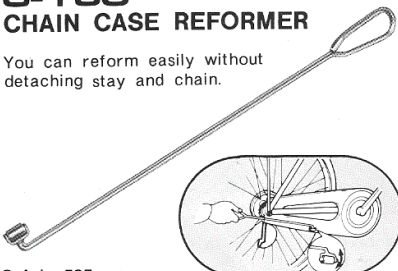

O.A.L. 565 mm

**C-131 RING NUT WRENCH FOR CHAIN CASE**



This unique tool can fit to every kinds of bracket axles and adjust 3 & 4 grooves ring.

C-132 SPARE PEG

**C-140 STAND SPRING TOOL**



Easy operation by leverage action.  
O.A.L. 195 mm

**C-151 4-HOLE BOX WRENCH**

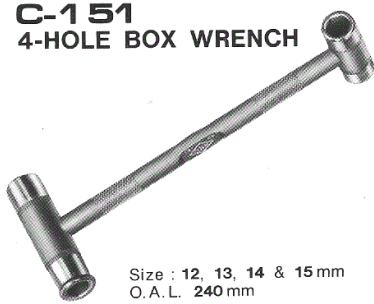

Size : 12, 13, 14 & 15 mm  
O.A.L. 240 mm

**C-152 4-HOLE BOX WRENCH with SPRING**

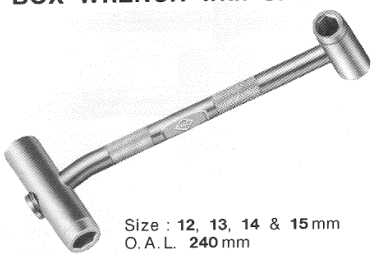

Size : 12, 13, 14 & 15 mm  
O.A.L. 240 mm

**C-157 OFFSET WRENCH**



For hub nuts.  
Size : 14×15 mm  
O.A.L. 300 mm

**C-159 10-WAY BOX WRENCH**



Diecast Alumi. Chrome plated  
Size : 6, 7, 8, 9, 10, 11, 12, 13, 14 & 15 mm

**C-160 HUB NUT RATCHET WRENCH**



Long box type for 14 & 15 mm  
Especially useful for fixing bolts of B.B.  
O.A.L. 260 mm

**C-201 PEDAL WRENCH**



Drop forged steel.  
Cranked sharp for pedal spindle.  
O.A.L. 300mm

**C-202 HEAVY DUTY PEDAL WRENCH**

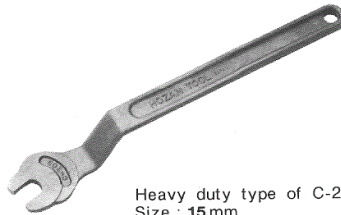

Heavy duty type of C-201  
Size : 15mm  
O.A.L. 330mm

**C-203 HEAD SCREW CONE PLIER**



For head parts assembly, bottom bracket or all dia. of lockrings.  
O.A.L. 275mm

**C-205 HEAD LOCK RING WRENCH**

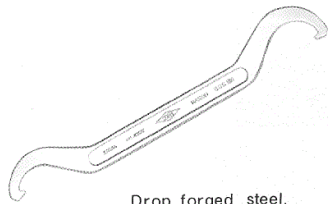

Drop forged steel.  
For all dia. of lockrings  
O.A.L. 250mm

**C-207 B.B. CUP STOPPER**

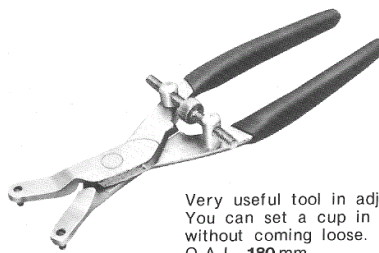

Very useful tool in adjusting a cup.  
You can set a cup in good position  
without coming loose.  
O.A.L. 180mm

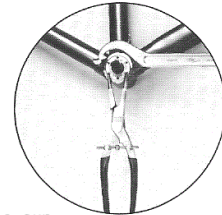

SPARE PEG



**C-210 BRAKE TOOL**



2 pcs. set of caliper brake arm alignment tools,  
with straightener for madguard stay and  
brake shoes, tire lever.

**C-214 WIRE CUTTER**

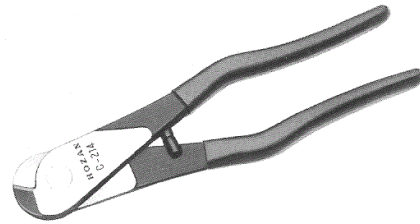

For cutting outer and inner of brake wire.  
O.A.L. 185mm

**C-217 SPOKE CUTTER**

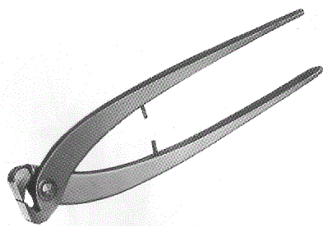

For cutting spoke end.  
O.A.L. 250mm

**C-218 SPOKE CUTTER FOR SPORTS CYCLE**

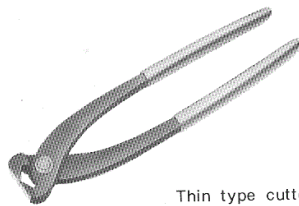

Thin type cutter  
Width : 8.6mm  
O.A.L. 280mm

**BRAKE SHOE CLAMP**

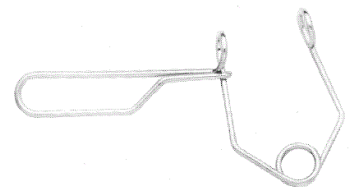

Spring operated  
U-C-P finish.

**C-253 HUB CONE ADJUSTING PLIER**

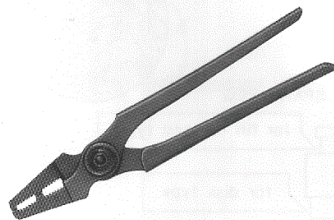

O.A.L. 280mm

**C-255·256 FORKED SCREW DRIVER FOR DOUBLE GEAR**

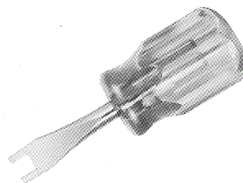

Stopper for double gear  
C-255 : 10mm C-256 : 12mm

**C-305 PEDAL & CRANK REFORMER**

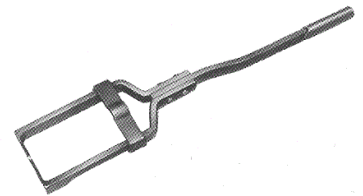

For easy reforming of pedal & crank.  
O.A.L. 630mm

# CYCLE TOOLS

## C-301 PERMANENT CHAIN RIVET EXTRACTOR

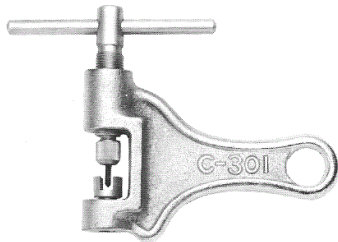

C-314 SPARE T-BAR



C-315 SPARE PIN



## C-303 MUDGUARD HOLE PUNCH

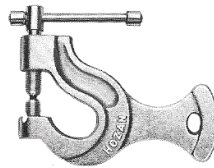

C-304 SPARE T-BAR



## C-320 CHAIN RIVET PLIER

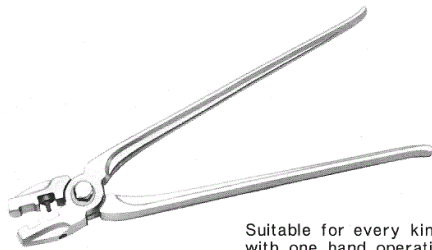

In case of extracting

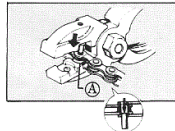

In case of rivetting

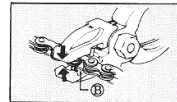

C-321 SPARE BOLT PIN



Suitable for every kind of bicycle chains with one hand operation.  
O.A.L. 240 mm

## C-325 MUDGUARD HOLE PUNCH PLIER

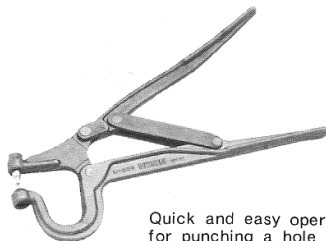

C-326 SPARE PIN



Quick and easy operation by leverage action for punching a hole for reflector and brace.  
O.A.L. 250 mm

## C-335 RIM CENTER GAUGE

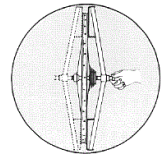
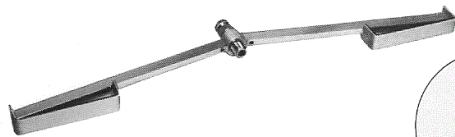

Use for the exact centering of the bicycle rim over cone lock nuts. Especially useful for correct dishing of rear wheel.  
Suitable for 18-28" rims.  
O.A.L. 675 mm

## C-330 WHEEL BUILDING STAND

The wheel building stand allows a beginner to correct any up-and-down or side-to-side movement of the rim.  
Suitable for all diameter and all widths.

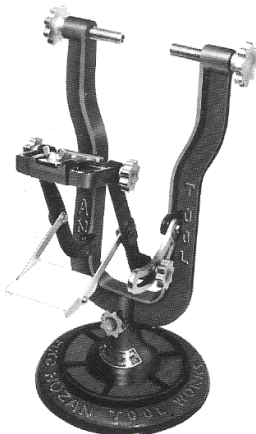

Weight : 15 kgs.

## C-336 GAUGE FOR DERAILLEUR

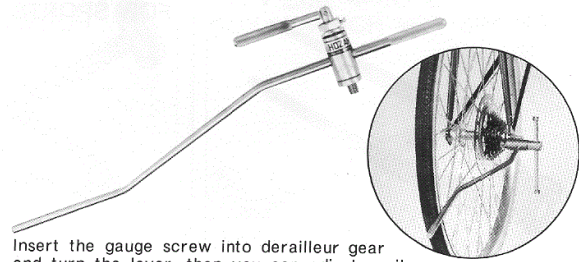

Insert the gauge screw into derailleur gear and turn the lever, then you can adjust easily.

## C-349 BRAKE DRUM TURNER

Usually, brake drums are tightened up. This unique power tool allows you to remove it easily.



O.A.L. 380 mm

C-350 SPARE PEG

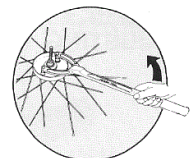
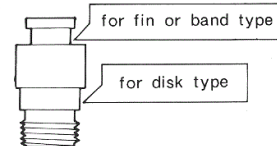

**C-352**  
FREE WHEEL TURNER



O.A.L. 310 mm

**C-354** HUB SPINDLE  
SLIPPING HOLDER



O.A.L. 290 mm

**C-356** INNER WIRE PLIER



O.A.L. 180 mm

**C-358** RIGHT BOTTOM BRACKET  
CUP TURNER

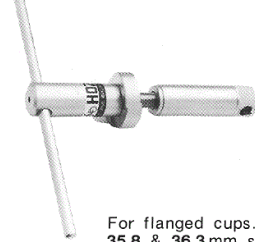

For flanged cups.  
35.8 & 36.3 mm sized jaw

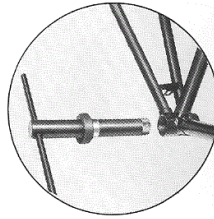

**C-359** BOTTOM BRACKET CUP TURNER



Available for all types as under

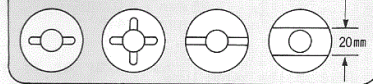

O.A.L. 300 mm

**C-360**  
FORK ALIGNMENT TOOL

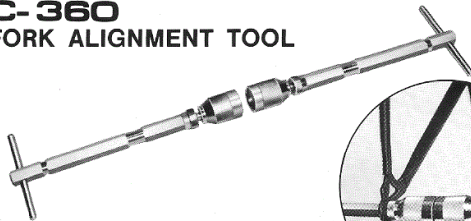

Front and rear drop out alignment tool.  
For checking and correcting fork end  
in parallel width : -  
front fork-100mm, rear end-120mm

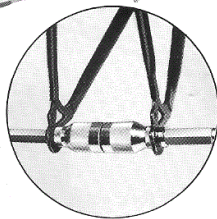

**C-361** HAMMER FOR CROWN BALL RACE

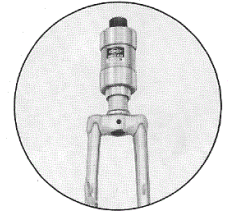

Moving up and down by hand press,  
sets crown ball race in perfect.

**C-363** REMOVER OF CROWN BALL RACE



Put on the crown ball race like fig.  
and struck with soft hammer,  
it is removed without damage.

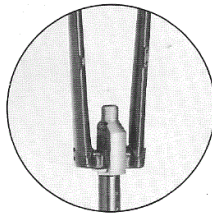

**C-365**  
TOP & BOTTOM BALL HEAD CUP REMOVER



Insert into head pipe and struck with  
soft hammer, the head cup is removed  
without damage.

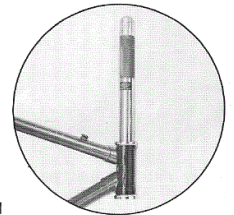

**C-366** TOOL FOR PUTTING TOP  
& BOTTOM HEAD CUPS

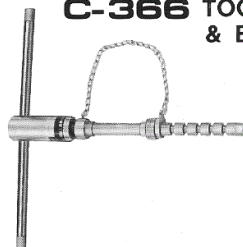

By pressing top and bottom head cups at  
same time, you can set accurately.

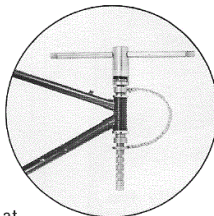

**HOZAN**  
TOOLS FOR BICYCLE

# CYCLE TOOLS

## C-401 PEDAL TAP with REAMER



Size : -  
9/16" × 20th.  
1/2" × 20th.

## C-402 BOTTOM BRACKET TAP with REAMER

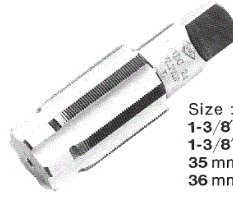

Size : -  
1-3/8" × 24 th.  
1-3/8" × 26 th.  
35 mm × 1.0 mm  
36 mm × 24 th.

For chasing to corrosion, eliminate paint and a few damaged thread.

## C-407 REAMER FOR CRANK AXLE



O. A. L. 135 mm

## C-405 BRACKET TAP with CENTER GUIDE

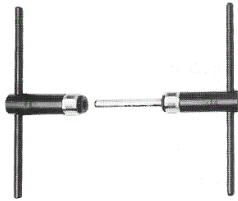

Size : -  
1-3/8" × 24 th.  
1-3/8" × 26 th.  
35 mm × 1.0 mm  
36 mm × 24 th.

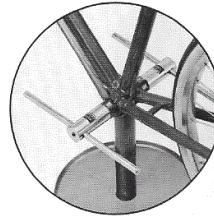

For tapping work both sides at the same time.

## C-408 REAMER FOR FORK COLUMN



O. A. L. 190 mm

## C-413 STOCK & DIES

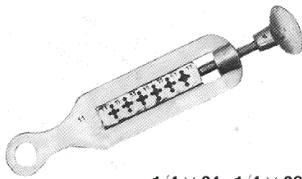

1/4 × 24, 1/4 × 26  
3/8 × 26, 9/32 × 30  
5/16 × 18, 5/16 × 26  
O. A. L. 270 mm

## C-421 STOCK & DIE FOR FORK COLUMN A

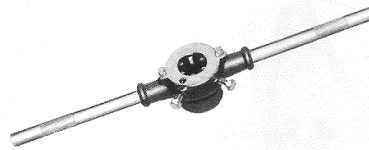

English  
1" × 24



Raleigh  
1" × 26



French  
25 mm × 1.0 mm

For cleaning and repairing of fork column that was damaged or corroded.

## C-450 STAY OPENER & TIGHTENER

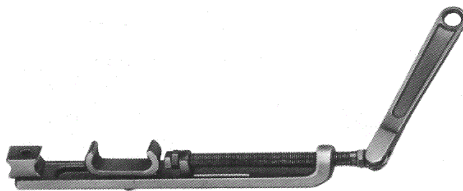

Stay catcher that padded with leather does not mound the frame, and has no slip for angled stay as like mini-cycle.

Using as opener

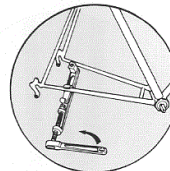

Using as tightener

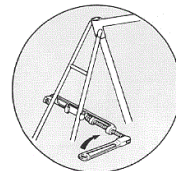

If you use a pair of C-450, you can reform bended it.

## C-465 HANDLE STEM POWER PULLER

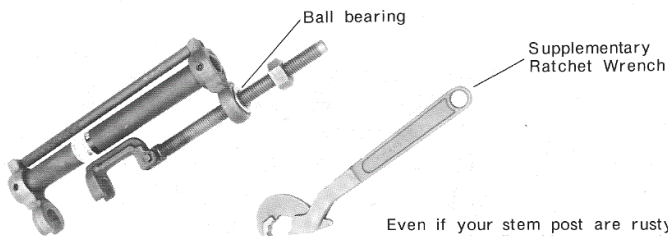

Even if your stem post are rusty and tight too hardly, this power tool extract it easily by your little power.



Capacity length of stem : Max. 250 mm

**C-500 COMBINATION WRENCH SET**

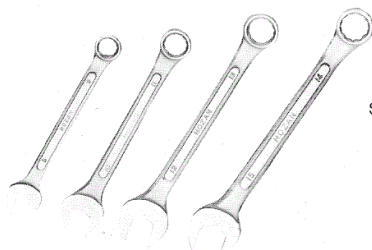

Size : Open × Ring  
 8 × 9  
 10 × 11  
 12 × 13  
 15 × 14 mm

Drop forged Chr.-Mo. steel.

**C-503 HUB CONE WRENCH SET (2 PCS. SET)**



Double sized open end 13 & 14 × 15 & 16 mm

**C-505 9-WAY SPANNER**



9, 10, 12, 13, 14, 15, 17 mm

**C-508 CYCLIST SPANNER**

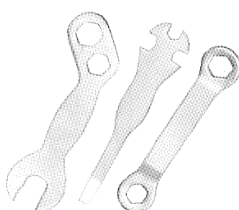

8, 9, 10, 12, 13, 14, 15 mm

**C-511 SPANNER & LOCK RING WRENCH**

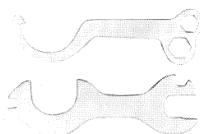

6, 9, 11, 14, 15, 16, 33 mm & Ring Wrench

**C-507 HUB CONE WRENCH SET (2 PCS. SET)**

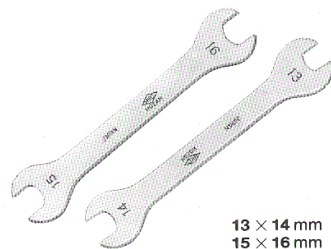

13 × 14 mm  
 15 × 16 mm

**C-611 MULTI. REPAIR TOOL SET**

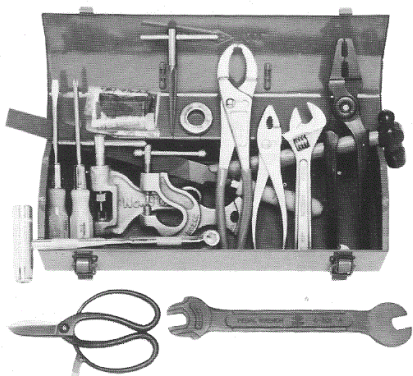

- Contents:-  
 C-151&C-103 4-Hole Box Wrench  
 C-119 Spoke Wrench  
 C-203 Head Screw Cone Plier  
 C-201 Pedal Wrench  
 C-253 Hub Cone Adjusting Plier  
 C-301 Chain Rivet Extractor  
 C-303 Mudguard Hole Punch  
 P-211 Slip Joint Plier 200mm  
 W-210 Adjustable Angle Wrench 200mm  
 D-111 Screw Driver 100 mm  
 D-135 Phillips Type Screw Driver No.2  
 C-55 Scissors  
 U-24 Ball Pein Hammer 1/2 lb.  
 K-4A Reamer  
 Flat File 250mm  
 Patch Rubber Set  
 B-83 Tool Box

**C-650 PORTABLE TOOL SET**



**C-651 PORTABLE TOOL SET**



**C-652 PORTABLE TOOL SET**



**C-653 PORTABLE TOOL SET**

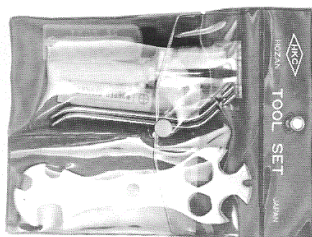

**C-654 PORTABLE TOOL SET**

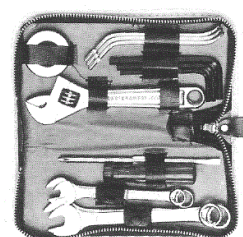



# CYCLE TOOLS

## C-915 SPOKE SCREWING MACHINE

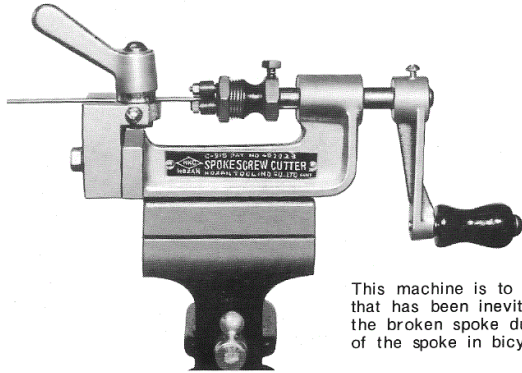

This machine is to delete the inconvenience that has been inevitable for fixing up the broken spoke due to many different sizes of the spoke in bicycles and motor cycles.

### REPLACEMENT ROLLING HEAD



Complete set comes with a rolling head 14-15 G.  
 C-917 for 14-15 G. (adjustable)  
 C-918 13 G.  
 C-919 12 G.  
 C-920 11 G.  
 C-921 10 G.  
 C-922 9 G.  
 C-923 8 G.

## B-305 SPOKE CABINET

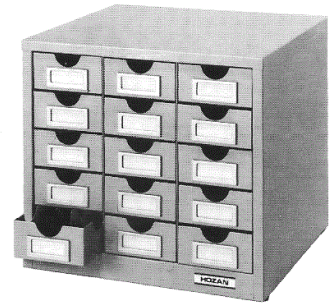

Spoke cabinet allows ideal storage and inventory of all spokes.

Dimension : 365 × 338 × 325 mm  
 Weight : 14 kgs.

Colour : ivory white

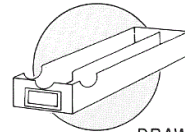

DRAWER 108 × 330 × 53 mm

## C-737 SPOKE TENSION METER

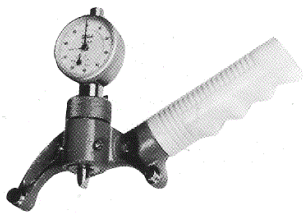

For measuring tensile strength of spoke.  
 To fit 14, 15 & 15-16-15 G.

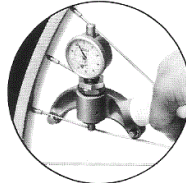

Hook the supporting point to the spoke and press the handle of the tester till it touches the stopping point to the same spoke, then read the figure in the dial gauge. The figure indicates the tension in the graph.

## C-733 SPOKE GAUGE



For measuring Gauge of spoke : 15-10 G.  
 Spoke length : Max. 350 mm  
 Hex. nut & Bolt dia.

## B-54 BOX MASTER

Size : 380(L) × 180(W) × 160(H) mm  
 Capacity : abt. 6.5 litre  
 Weight : 1.3 kgs.

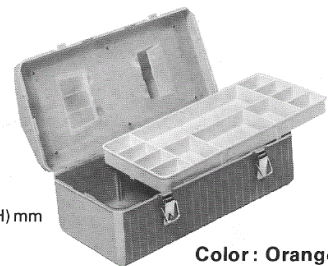

Color : Orange Blue

## B-56 BOX MASTER

Size : 440(L) × 225(W) × 245(H) mm  
 Capacity : abt. 16.0 litre  
 Weight : 3.8 kgs.

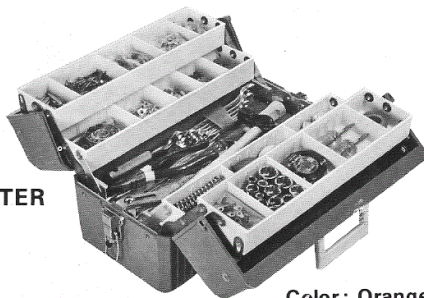

Color : Orange Blue  
 (Tools shown in photo not included)

## B-55 BOX MASTER

Size : 440(L) × 225(W) × 230(H) mm  
 (Parts Tray : 375 × 95 × 45 mm × 2)  
 Capacity : abt. 12.0 litre  
 Weight : 2.9 kgs.

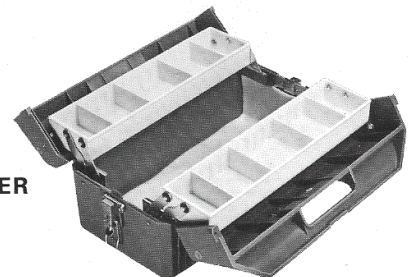

Color : Orange Blue

### BOX MASTER (TOOL CASE) Elegant design and unique function are attracting public attention

When the cover is removed, small parts trays are opened automatically so that you may take them very easily. You may classify the small parts trays optionally and freely (free divider). Very robust design and ABS resin thick wall molding. When dropped with 20kgs. load, it will withstand it. Beauty inherent in resin and unique design.

**W-90 ALLEN WRENCHES**



Size : 3mm 4mm 5mm 6mm

**W-92 . 95 ALLEN WRENCH SET**

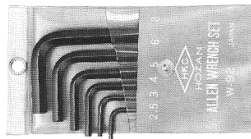

W-92 : 2.5, 3, 4, 5, 6, 8 mm (6 pcs.)  
W-95 : 2.5, 3, 4, 5, 6, 8, 10, 12 mm (8 pcs.)

**W-93 . 97 ALLEN WRENCH SET on RING**

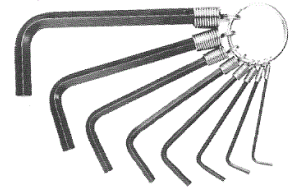

W-93 : 4, 5, 6 mm  
W-97 : 2, 2.5, 3, 4, 5, 6, 8, 10 mm

**W-94 FLEX. ALLEN WRENCH**

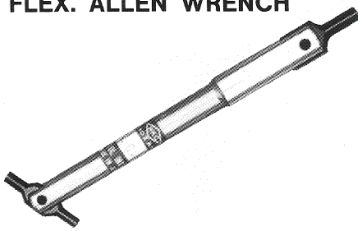

Size : 4, 5, 6 & 7 mm

**W-98 10 PCS. ALLEN WRENCH SET**

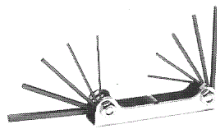

Size : 1.5, 2, 2.5, 3, 4 mm  
1/20, 1/16, 3/32, 1/8, 3/16 in.

**NO.68106 T-TYPE WRENCH with ALLEN WRENCH**

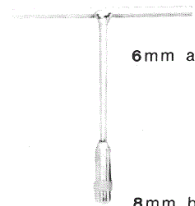

6mm allen wrench

8mm box wrench

**W-105 . 106 . 108 T-TYPE POWER ALLEN WRENCH**

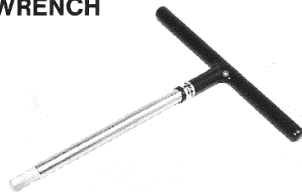

W-105 5 mm  
W-106 6 mm  
W-108 8 mm

**W-210 ADJUSTABLE ANGLE WRENCH**

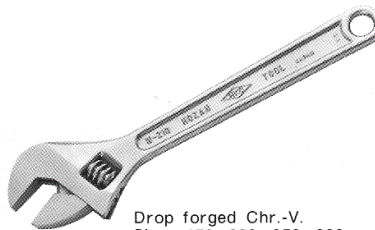

Drop forged Chr.-V.  
Size : 150, 200, 250, 300 mm

**NO.016-1 . 016-2 BALL POINT ALLEN WRENCH SET**

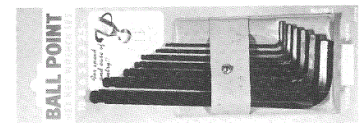

016-1 : 2.5, 3, 4, 5, 6, 8, 10 mm  
016-2 : 3/32, 1/8, 5/32, 3/16, 1/4, 5/16, 3/8 in.

**W-5 T-TYPE BOX WRENCH**

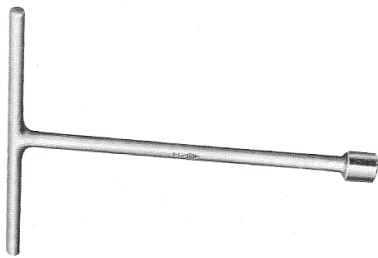

Size : 8, 9, 10, 11, 12, 13, 14 mm

**W-11 Y-TYPE BOX WRENCH**

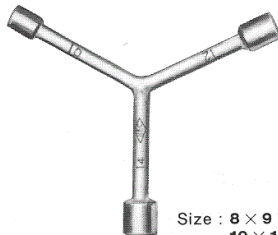

Size : 8 × 9 × 10 mm  
10 × 12 × 14 mm

**W-96 Y-TYPE ALLEN WRENCH**

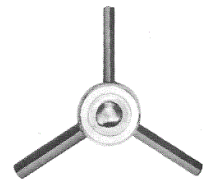

Size : 4, 5, 6 mm

**W-521 OPEN END WRENCH SET**



Size : 6 × 7, 8 × 10, 11 × 13, 12 × 14,  
17 × 19, 22 × 24 mm

**B-217 SOCKET WRENCH SET**

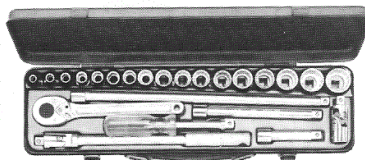

Contents : 17 pcs. Socket, Ratchet handle,  
Spindle, Extension bar, Universal joint,  
Driver type handle.

**M-2506 OFFSET WRENCH SET**

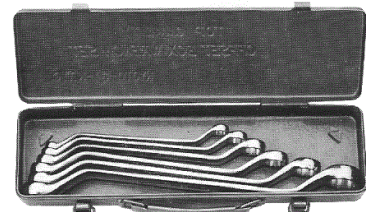

Size : 8 × 10, 11 × 13, 12 × 14, 17 × 19,  
22 × 24, 24 × 27 mm

# MOTORCYCLE TOOLS

## A-928A · 928B POWERFUL CHAIN RIVET EXTRACTOR

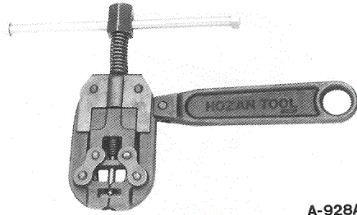

Available for all motor cycle chains.

A-928A for #520-530, #50 chain  
A-928B for #420-428, #40 chain

In case of straight pin

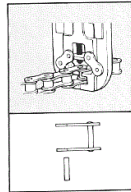

In case of narrowed pin

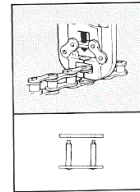

## A-155 STRAIGHT TYPE SPOKE WRENCH

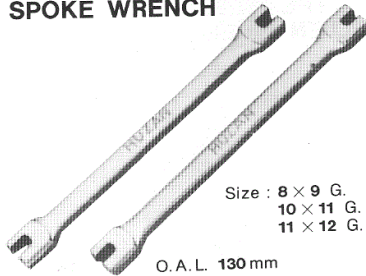

Size : 8 × 9 G.  
10 × 11 G.  
11 × 12 G.

O.A.L. 130 mm

## A-192 CLUTCH TOOL



Outer holder to fit generally motor cycles.

## A-196 FLYWHEEL PULLER

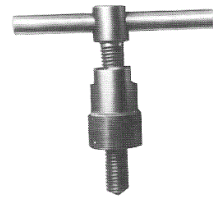

For motor cycle 50-125 c.c.

## A-981 FLYWHEEL MAGNET PULLER

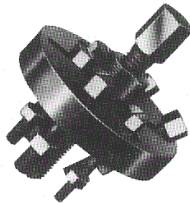

Universal round type for all Japanese machines.

## T-12 VALVE DRIVER



Use for removing valve cores.

## TIRE LEVERS



T-221 240 mm  
T-222 280 mm  
T-223 400 mm  
T-238 Slotted type

## A-340 WHEEL BUILDING STAND

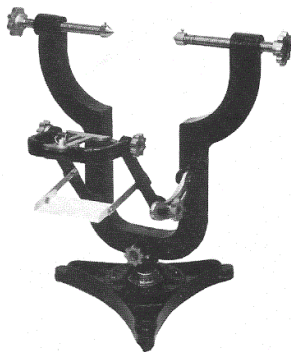

Suitable for any size of cycle and MC wheel. Enamelled finish.  
Height : 550 mm  
Weight : 20 kgs.

## E-200 VALVE SPRING TOOL

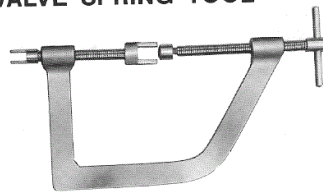

Fits almost all overhead valve cycles.  
Has reversible collar and with two sizes of holders.

## SPARK PLUG WRENCHES

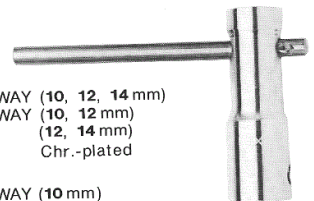

3-WAY (10, 12, 14 mm)  
2-WAY (10, 12 mm)  
(12, 14 mm)  
Chr.-plated  
1-WAY (10 mm)  
(12 mm)  
(14 mm)  
Uni-Chr-plated

## SPARK PLUG TAP SET

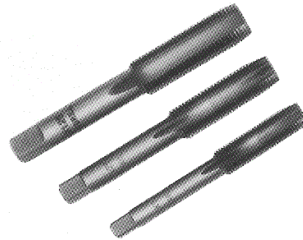

3 pcs. set (10, 12, 14 mm)

## NO.2670 AUTO TESTING SCREW DRIVER

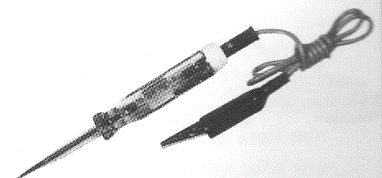

Checking automobile electric system.  
For 2.8-24V.

**K-4 REAMER**

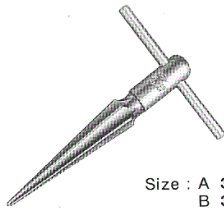

Size : A 3.0-10 mm  
 B 3.5-13 mm  
 C 9.0-19 mm  
 D 3.5-19 mm  
 E 4.0-31 mm

**K-116 CENTER PUNCH**

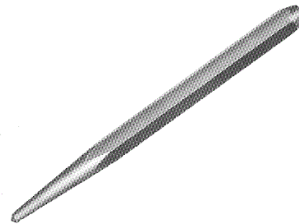

11 mm dia. 150 mm length

**K-415S STOCK & DIES SET**

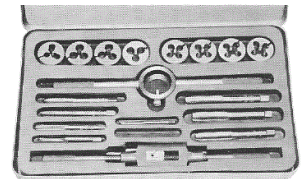

Contents :  
 Tap & die 3, 4, 5, 6, 7, 8, 9, 10mm  
 Tap handle & stock

**N-12 CUTTING PLIER**

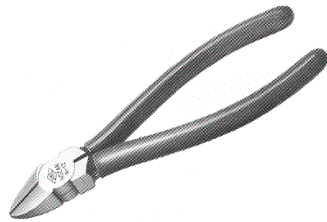

Heavy duty cutter for hard wires. 150 mm

**P-12 BENT NOSE PLIER**

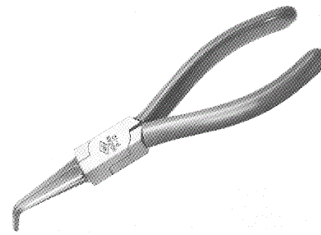

Bent at 60° for gripping, looping and twisting wires in complicated space. 150 mm

**P-13 LONG NOSE PLIER**

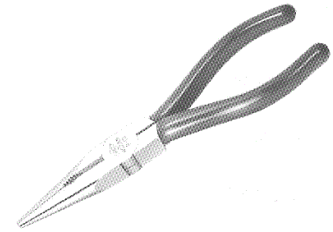

Designed for tightening a loosening nut and small pipes. 150 mm

**P-43 SIDE CUTTING PLIER**



Size : 125, 150, 175, 200 mm

**P-211 SLIP JOINT PLIER**



Has deep serrated jaws for pipe gripping.  
 Size : 150, 200 mm

**TC-200 MINI. CLIPPER**

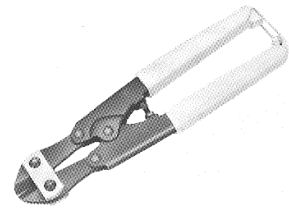

Easy cutting with spring action.  
 Cutting cap. Hard wire 1.5 mm  
 Soft wire 4.0 mm

**P-244 MINI. PUMP PLIER**



Cap : 20 mm

**P-245 PUMP PLIER**

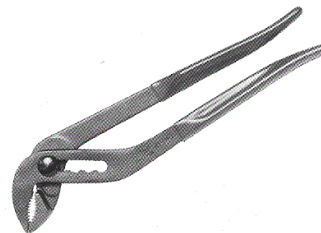

Cap : 42 mm Drop forged of Ni.-Chr.-Mo.

**SOCP-130 CONVERTIBLE CIRCLIP PLIER**

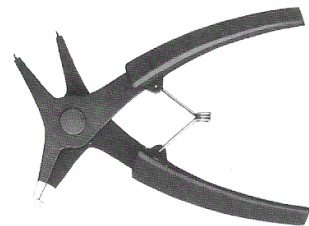

Cap : 10-40 mm

**E-300 ADJUSTABLE REAMER**



Size : -  
 F : 19.75-21.5 mm  
 G : 21.5-23.75 mm  
 H : 23.75-27.0 mm  
 I : 27.0-30.5 mm

**U-24 BALL PEIN HAMMER**



Size O. A. L.  
 1/2 lb. 300 mm  
 1 lb. 325 mm  
 1-1/2 lb. 345 mm  
 2 lb. 360 mm

**U-70 PLASTIC HAMMER**

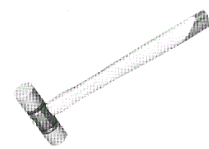

Size O. A. L.  
 1/2 lb. 280 mm  
 1 lb. 295 mm  
 1-1/2 lb. 330 mm  
 2 lb. 350 mm

**D-111 PIERCING ROD SCREW DRIVER**

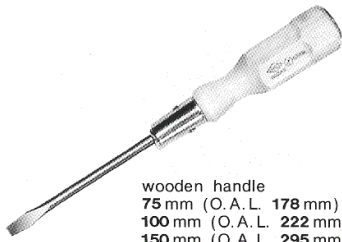

wooden handle  
75 mm (O.A.L. 178 mm)  
100 mm (O.A.L. 222 mm)  
150 mm (O.A.L. 295 mm)

**D-135 PIERCING ROD PHILLIPS TYPE SCREW DRIVER**



wooden handle  
No. 1 (O.A.L. 181 mm)  
No. 2 (O.A.L. 222 mm)  
No. 3 (O.A.L. 295 mm)

**D-43 SCREW DRIVER**

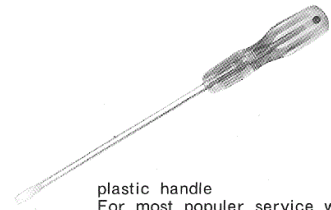

plastic handle  
For most popular service work.  
100 mm (O.A.L. 179 mm)  
150 mm (O.A.L. 229 mm)  
200 mm (O.A.L. 279 mm)

**D-350 LONG HEX. NUT DRIVER SET**



3 pcs. set (8, 9, 10 mm) O.A.L. 400 mm

**D-360 LONG SCREW DRIVER SET**



2 pcs. set (+) (-) O.A.L. 400 mm

**D-369 SQUARE ROD LONG SCREW DRIVER**



No.2 × 300 mm Magnetic blade

**D-370 DEEP BOX DRIVER**



3 pcs. set (8, 9, 10 mm)

**D-50 NUT DRIVER**

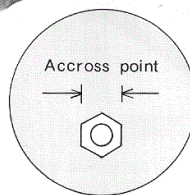

Size : 4, 4.5, 5, 5.5, 6, 7, 8, 9, 10 mm

**NO.2620 SPARK PLUG TESTING SCREW DRIVER**

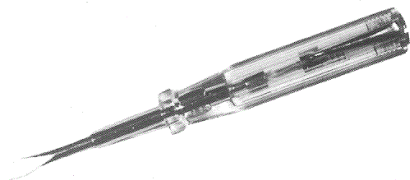

Diameter of blade 4 mm

**D-581 COMFORT GRIP SCREW DRIVER D-581 L LONG TYPE**



Fully hardened & magnetic blade  
6.3 mm × 100 mm, 6.3 mm × 300 mm

**D-585 COMFORT GRIP PHILLIPS TYPE SCREW DRIVER D-585 L LONG TYPE**



Fully hardened & magnetic blade  
No.2 × 100 mm, No.2 × 300 mm

**D-380 RATCHET LONG DRIVER SET**



Replacement rod : No.2 × 300 mm, 6 mm × 300 mm

**D-962 IMPACT DRIVER**

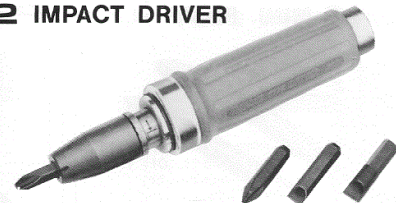

Adaptor bit : 8, 10 mm  
No.2, No.3  
Striking end of handle with hammer,  
turn drive in either direction, for  
stubborn screws.

**NO.2630 AUTO TESTING SCREW DRIVER**

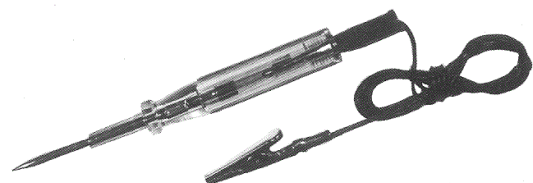

Cap : 6-24 V.  
Diameter of blade 4 mm

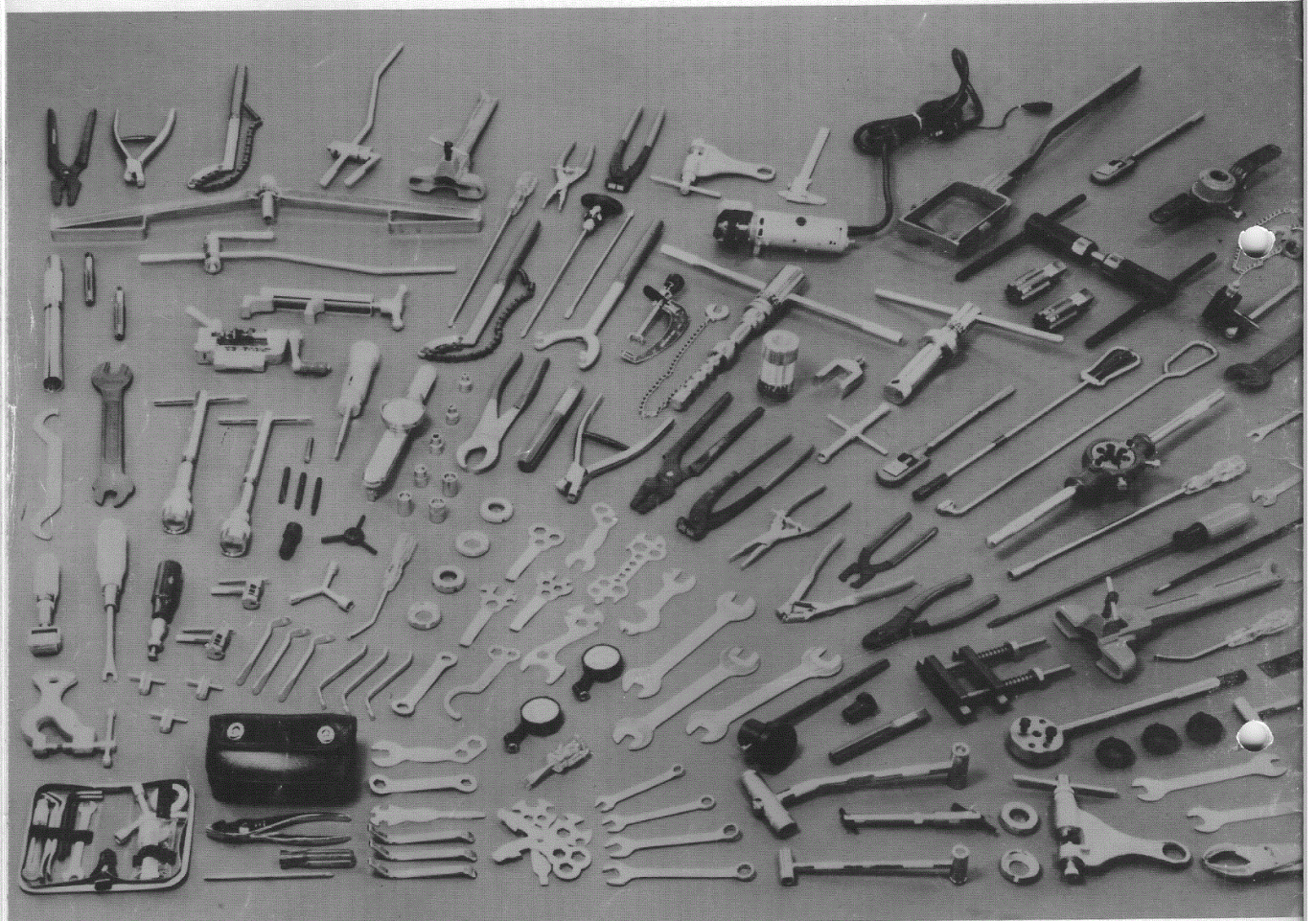

# HOZAN

HOZAN TOOL INDUSTRIAL CO., LTD.

HEAD OFFICE : 1-2-12, Saiwaicho Naniwa-ku, Osaka 556, Japan  
Telephone : Osaka (06) 562-0021 Fax : (06) 562-0024

TELEX(Public) J63400 OSAINBTH  
ATT : OSA-66 HOZANTOOL 567-3111

CABLE ADDRESS : HOZANTOOL OSAKA  
TOKYO • NAGOYA • OSAKA • FUKUOKA